

## Optocoupler, Phototransistor Output, with Base Connection

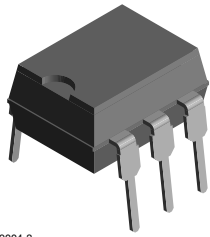

H179004-3

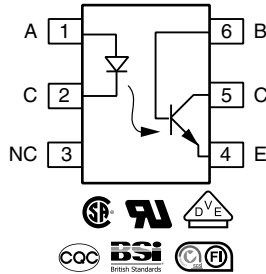

### FEATURES

- Interfaces with common logic families
- Input-output coupling capacitance < 0.5 pF
- Industry standard dual-in line 6-pin package
- Isolation test voltage: 5300 V<sub>RMS</sub>
- Material categorization:  
for definitions of compliance please see [www.vishay.com/doc?99912](http://www.vishay.com/doc?99912)



RoHS COMPLIANT

### DESCRIPTION

The H11Ax family is an industry standard single channel phototransistor coupler. It includes the H11A1, H11A2, H11A3, H11A4, H11A5 couplers.

Each optocoupler consists of gallium arsenide infrared LED and a silicon NPN phototransistor.

The isolation performance is accomplished through Vishay double molding isolation manufacturing process. Compliance to DIN EN 60747-5-5 partial discharge isolation specification is available is by ordering option 1.

These isolation processes and the Vishay ISO9001 quality program results in the highest isolation performance available for a commercial plastic phototransistor optocoupler.

The devices are available in lead formed configuration suitable for surface mounting and are available either on tape and reel, or in standard tube shipping containers.

#### Note

- Designing with data sheet is covered in Application Note 45.

### APPLICATIONS

- AC mains detection
- Reed relay driving
- Switch mode power supply feedback
- Telephone ring detection
- Logic ground isolation
- Logic coupling with high frequency noise rejection

### AGENCY APPROVALS

- UL1577, file no. E52744 system code H or J, double protection
- CSA 93751
- BSI IEC 60950; IEC 60065
- DIN EN 60747-5-5 (VDE 0884-5), available with option 1
- FIMKO
- CQC

| ORDERING INFORMATION  |                            |             |       |                |       |               |
|---|----------------------------|-------------|-------|----------------|-------|---------------|
| <div style="display: flex; justify-content: space-around; align-items: center;"> <div style="border: 1px solid black; padding: 2px;">H</div> <div style="border: 1px solid black; padding: 2px;">1</div> <div style="border: 1px solid black; padding: 2px;">1</div> <div style="border: 1px solid black; padding: 2px;">A</div> <div style="border: 1px solid black; padding: 2px;">#</div> <div style="border: 1px solid black; padding: 2px;">-</div> <div style="border: 1px solid black; padding: 2px;">X</div> <div style="border: 1px solid black; padding: 2px;">0</div> <div style="border: 1px solid black; padding: 2px;">0</div> <div style="border: 1px solid black; padding: 2px;">#</div> <div style="border: 1px solid black; padding: 2px;">X</div> </div> |                            | PART NUMBER |       | PACKAGE OPTION |       | TAPE AND REEL |
|   |                            |             |       |                |       |               |
| AGENCY CERTIFIED/PACKAGE  | CTR (%)                    |             |       |                |       |               |
| UL, CSA, BSI, FIMKO, CQC  | > 50                       | > 20        |       | > 10           | > 30  |               |
| DIP-6   | H11A1,<br>H11A1-X001       | H11A2       | H11A3 | H11A4          | H11A5 |               |
| DIP-6, 400 mil, option 6  | H11A1-X006                 | -           | -     | -              | -     |               |
| SMD-6, option 7   | H11A1-X007,<br>H11A1-X017  | -           | -     | -              | -     |               |
| SMD-6, option 9   | H11A1-X009,<br>H11A1-X009T | -           | -     | -              | -     |               |

#### Note

- Additional options may be possible, please contact sales office.



| <b>ABSOLUTE MAXIMUM RATINGS</b> ( $T_{amb} = 25\text{ }^{\circ}\text{C}$ , unless otherwise specified) |  |            |                |                    |
|--|--|------------|----------------|--------------------|
| PARAMETER  | TEST CONDITION   | SYMBOL     | VALUE          | UNIT               |
| <b>INPUT</b>   |  |            |                |                    |
| Reverse voltage  |  | $V_R$      | 6              | V                  |
| Forward current  |  | $I_F$      | 60             | mA                 |
| Surge current  | $t \leq 10\text{ }\mu\text{s}$   | $I_{FSM}$  | 2.5            | A                  |
| Power dissipation  |  | $P_{diss}$ | 100            | mW                 |
| <b>OUTPUT</b>  |  |            |                |                    |
| Collector emitter breakdown voltage  |  | $V_{CEO}$  | 70             | V                  |
| Emitter base breakdown voltage   |  | $V_{EBO}$  | 7              | V                  |
| Collector current  |  | $I_C$      | 50             | mA                 |
|  | $t < 1\text{ ms}$  | $I_C$      | 100            | mA                 |
| Power dissipation  |  | $P_{diss}$ | 150            | mW                 |
| <b>COUPLER</b>   |  |            |                |                    |
| Isolation test voltage   |  | $V_{ISO}$  | 5300           | $V_{RMS}$          |
| Creepage distance  |  |            | $\geq 7$       | mm                 |
| Clearance distance   |  |            | $\geq 7$       | mm                 |
| Insulation thickness between emitter and detector  |  |            | $\geq 0.4$     | mm                 |
| Comparative tracking index   | per DIN IEC 112/VDE 0303, part 1   |            | 175            |                    |
| Isolation resistance   | $V_{IO} = 500\text{ V}, T_{amb} = 25\text{ }^{\circ}\text{C}$            | $R_{IO}$   | $\geq 10^{12}$ | $\Omega$           |
|  | $V_{IO} = 500\text{ V}, T_{amb} = 100\text{ }^{\circ}\text{C}$           | $R_{IO}$   | $\geq 10^{11}$ | $\Omega$           |
| Storage temperature range  |  | $T_{stg}$  | -55 to +150    | $^{\circ}\text{C}$ |
| Operating temperature range  |  | $T_{amb}$  | -55 to +100    | $^{\circ}\text{C}$ |
| Junction temperature   |  | $T_j$      | 100            | $^{\circ}\text{C}$ |
| Soldering temperature  | max. 10 s, dip soldering: distance to seating plane $\geq 1.5\text{ mm}$ | $T_{sld}$  | 260            | $^{\circ}\text{C}$ |

**Note**

- Stresses in excess of the absolute maximum ratings can cause permanent damage to the device. Functional operation of the device is not implied at these or any other conditions in excess of those given in the operational sections of this document. Exposure to absolute maximum ratings for extended periods of the time can adversely affect reliability.

| <b>ELECTRICAL CHARACTERISTICS</b> ( $T_{amb} = 25\text{ }^{\circ}\text{C}$ , unless otherwise specified) |   |       |             |      |      |      |               |
|--|---|-------|-------------|------|------|------|---------------|
| PARAMETER  | TEST CONDITION                                    | PART  | SYMBOL      | MIN. | TYP. | MAX. | UNIT          |
| <b>INPUT</b>   |   |       |             |      |      |      |               |
| Forward voltage  | $I_F = 10\text{ mA}$                              | H11A1 | $V_F$       |      | 1.1  | 1.5  | V             |
|  |   | H11A2 | $V_F$       |      | 1.1  | 1.5  | V             |
|  |   | H11A3 | $V_F$       |      | 1.1  | 1.5  | V             |
|  |   | H11A4 | $V_F$       |      | 1.1  | 1.5  | V             |
|  |   | H11A5 | $V_F$       |      | 1.1  | 1.7  | V             |
| Reverse current  | $V_R = 3\text{ V}$                                |       | $I_R$       |      |      | 10   | $\mu\text{A}$ |
| Capacitance  | $V_R = 0\text{ V}, f = 1\text{ MHz}$              |       | $C_O$       |      | 50   |      | pF            |
| <b>OUTPUT</b>  |   |       |             |      |      |      |               |
| Collector emitter breakdown voltage  | $I_C = 1\text{ mA}, I_F = 0\text{ mA}$            |       | $BV_{CEO}$  | 30   |      |      | V             |
| Emitter collector breakdown voltage  | $I_E = 100\text{ }\mu\text{A}, I_F = 0\text{ mA}$ |       | $BV_{ECO}$  | 7    |      |      | V             |
| Collector base breakdown voltage   | $I_C = 10\text{ }\mu\text{A}, I_F = 0\text{ mA}$  |       | $BV_{CBO}$  | 70   |      |      | V             |
| Collector emitter leakage current  | $V_{CE} = 10\text{ V}, I_F = 0\text{ mA}$         |       | $I_{CEO}$   |      | 5    | 50   | nA            |
| Emitter collector capacitance  | $V_{CE} = 0\text{ V}$                             |       | $C_{CE}$    |      | 6    |      | pF            |
| <b>COUPLER</b>   |   |       |             |      |      |      |               |
| Collector emitter, saturation voltage  | $I_{CE} = 0.5\text{ mA}, I_F = 10\text{ mA}$      |       | $V_{CEsat}$ |      |      | 0.4  | V             |
| Capacitance (input-output)   |   |       | $C_{IO}$    |      | 0.5  |      | pF            |

**Note**

- Minimum and maximum values were tested requirements. Typical values are characteristics of the device and are the result of engineering evaluations. Typical values are for information only and are not part of the testing requirements.



| CURRENT TRANSFER RATIO |  |       |            |      |      |      |      |
|------------------------|--|-------|------------|------|------|------|------|
| PARAMETER              | TEST CONDITION                             | PART  | SYMBOL     | MIN. | TYP. | MAX. | UNIT |
| $I_C/I_F$              | $V_{CE} = 10\text{ V}, I_F = 10\text{ mA}$ | H11A1 | $CTR_{DC}$ | 50   |      |      | %    |
|                        |  | H11A2 | $CTR_{DC}$ | 20   |      |      | %    |
|                        |  | H11A3 | $CTR_{DC}$ | 20   |      |      | %    |
|                        |  | H11A4 | $CTR_{DC}$ | 10   |      |      | %    |
|                        |  | H11A5 | $CTR_{DC}$ | 30   |      |      | %    |

| SWITCHING CHARACTERISTICS |  |           |      |      |      |      |               |
|---------------------------|--|-----------|------|------|------|------|---------------|
| PARAMETER                 | TEST CONDITION   | SYMBOL    | MIN. | TYP. | MAX. | UNIT |               |
| Turn-on time              | $I_C = 2\text{ mA}, R_L = 100\ \Omega, V_{CE} = 10\text{ V}$ | $t_{on}$  |      | 3    |      |      | $\mu\text{s}$ |
| Turn-off time             |  | $t_{off}$ |      | 3    |      |      | $\mu\text{s}$ |

**TYPICAL CHARACTERISTICS** ( $T_{amb} = 25\text{ }^\circ\text{C}$ , unless otherwise specified)

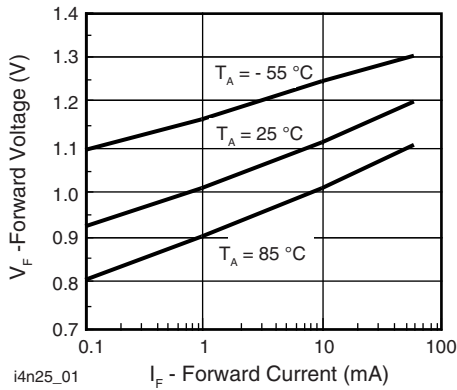

Fig. 1 - Forward Voltage vs. Forward Current

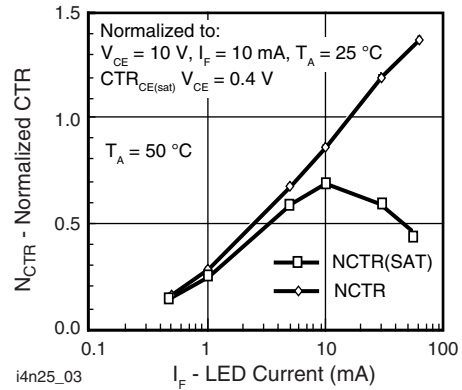

Fig. 3 - Normalized Non-Saturated and Saturated CTR vs. LED Current

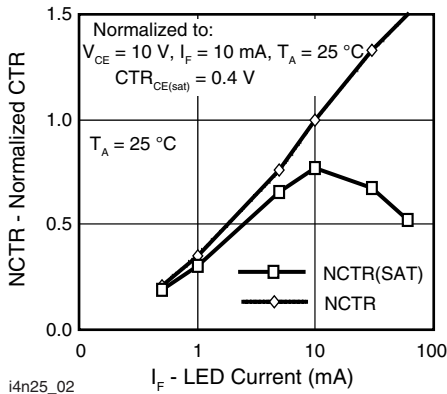

Fig. 2 - Normalized Non-Saturated and Saturated CTR vs. LED Current

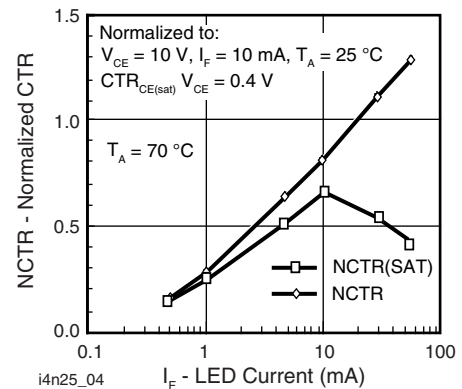

Fig. 4 - Normalized Non-Saturated and Saturated CTR vs. LED Current

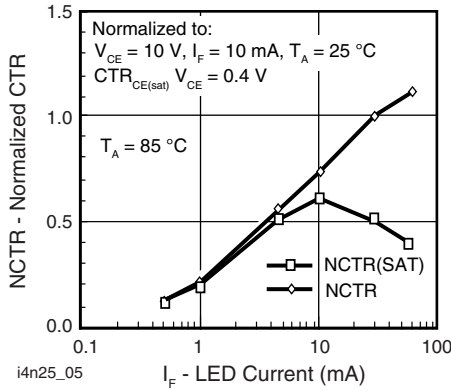

Fig. 5 - Normalized Non-Saturated and Saturated CTR vs. LED Current

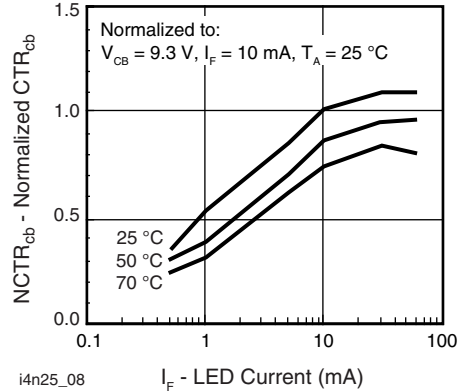

Fig. 8 - Normalized CTR<sub>cb</sub> vs. LED Current and Temperature

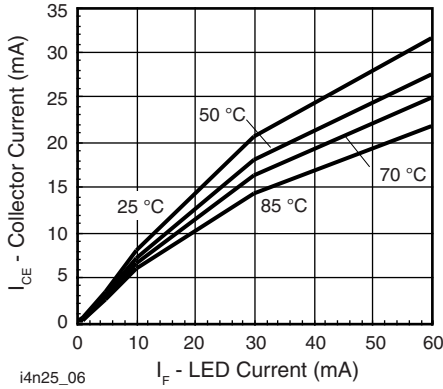

Fig. 6 - Collector Emitter Current vs. Temperature and LED Current

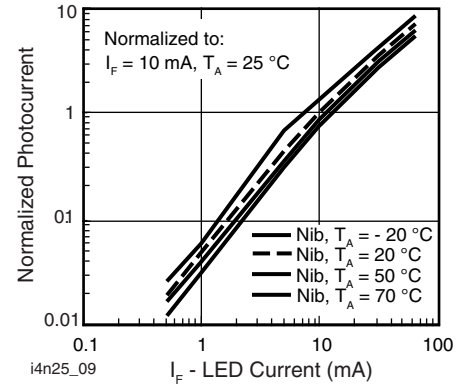

Fig. 9 - Normalized Photocurrent vs. I<sub>F</sub> and Temperature

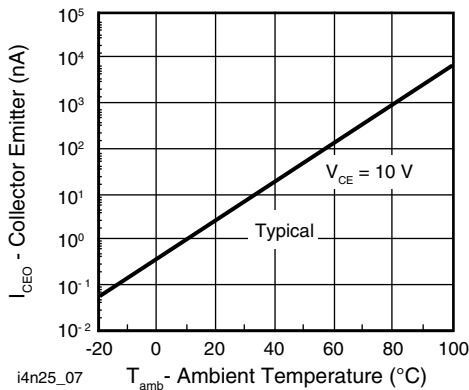

Fig. 7 - Collector Emitter Leakage Current vs. Temperature

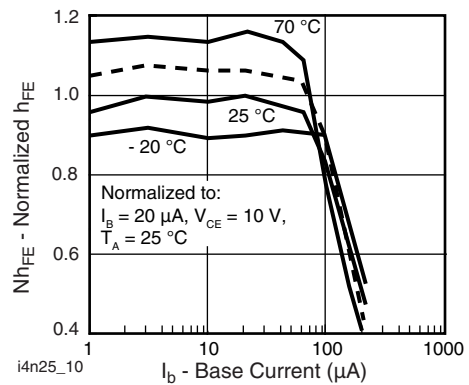

Fig. 10 - Normalized Non-Saturated h<sub>FE</sub> vs. Base Current and Temperature

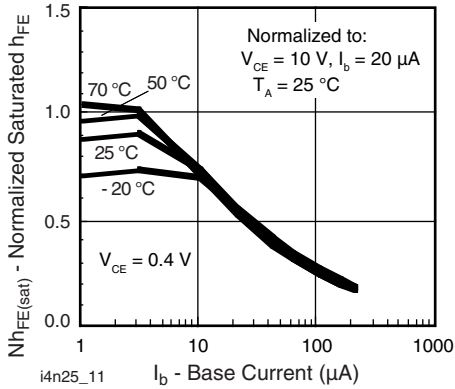
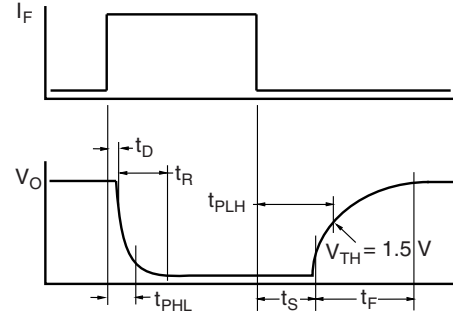
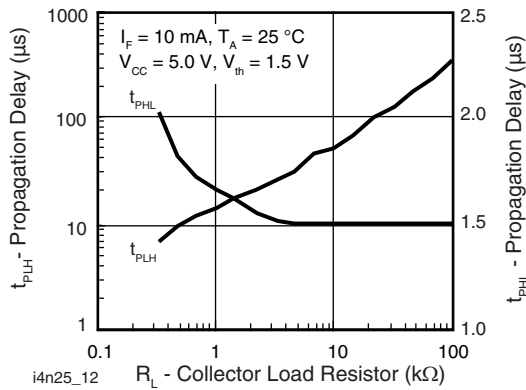

Fig. 11 - Normalized HFE vs. Base Current and Temperature



i4n25\_13

Fig. 13 - Switching Timing



i4n25\_12

Fig. 12 - Propagation Delay vs. Collector Load Resistor

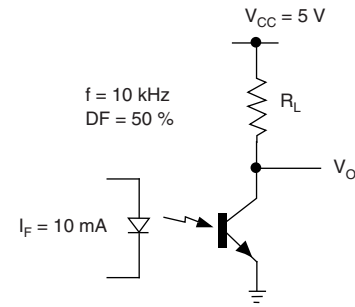

i4n25\_14

Fig. 14 - Switching Schematic



## PACKAGE DIMENSIONS in millimeters

### DIP-6



### Option 6

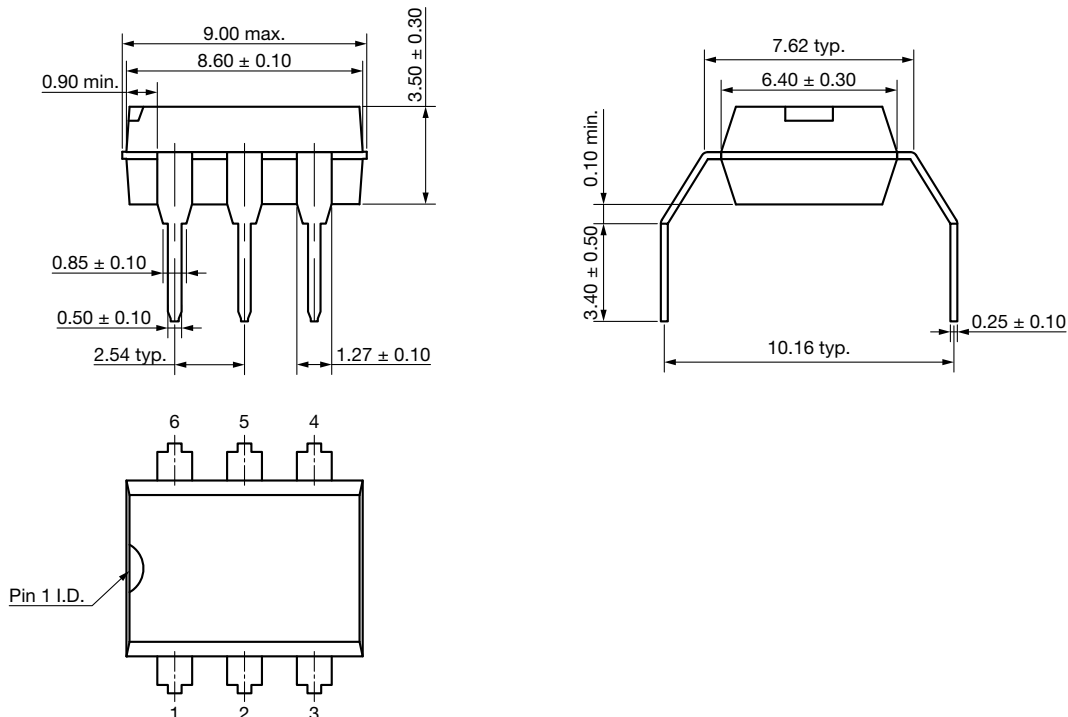

## Option 7

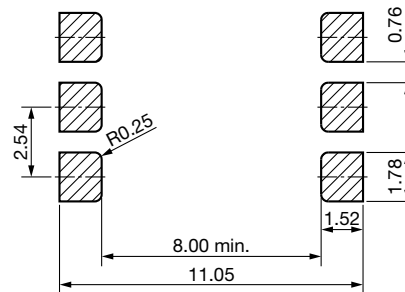
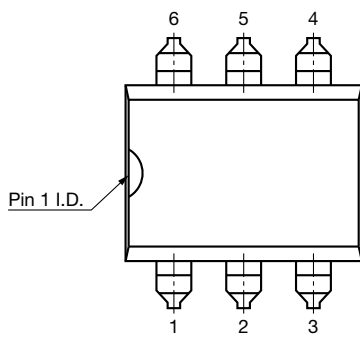
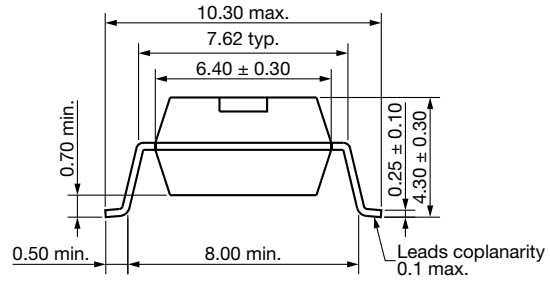
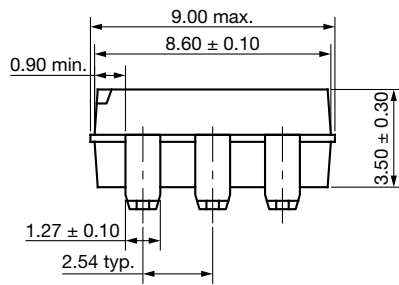

## Option 9

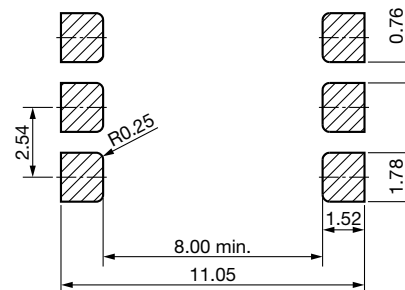
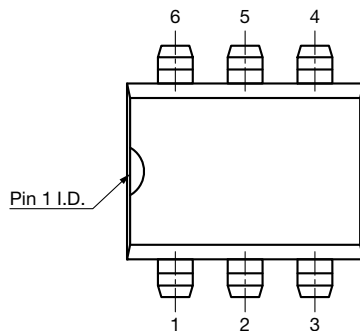
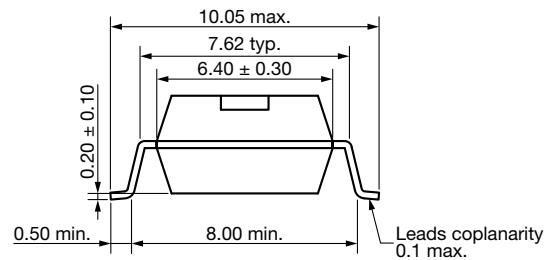
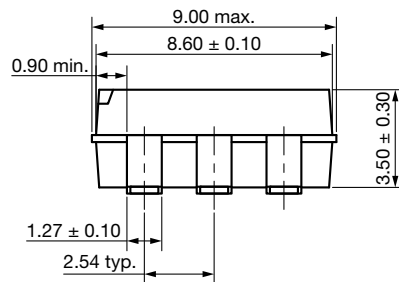



## Disclaimer

ALL PRODUCT, PRODUCT SPECIFICATIONS AND DATA ARE SUBJECT TO CHANGE WITHOUT NOTICE TO IMPROVE RELIABILITY, FUNCTION OR DESIGN OR OTHERWISE.

Vishay Intertechnology, Inc., its affiliates, agents, and employees, and all persons acting on its or their behalf (collectively, "Vishay"), disclaim any and all liability for any errors, inaccuracies or incompleteness contained in any datasheet or in any other disclosure relating to any product.

Vishay makes no warranty, representation or guarantee regarding the suitability of the products for any particular purpose or the continuing production of any product. To the maximum extent permitted by applicable law, Vishay disclaims (i) any and all liability arising out of the application or use of any product, (ii) any and all liability, including without limitation special, consequential or incidental damages, and (iii) any and all implied warranties, including warranties of fitness for particular purpose, non-infringement and merchantability.

Statements regarding the suitability of products for certain types of applications are based on Vishay's knowledge of typical requirements that are often placed on Vishay products in generic applications. Such statements are not binding statements about the suitability of products for a particular application. It is the customer's responsibility to validate that a particular product with the properties described in the product specification is suitable for use in a particular application. Parameters provided in datasheets and/or specifications may vary in different applications and performance may vary over time. All operating parameters, including typical parameters, must be validated for each customer application by the customer's technical experts. Product specifications do not expand or otherwise modify Vishay's terms and conditions of purchase, including but not limited to the warranty expressed therein.

Except as expressly indicated in writing, Vishay products are not designed for use in medical, life-saving, or life-sustaining applications or for any other application in which the failure of the Vishay product could result in personal injury or death. Customers using or selling Vishay products not expressly indicated for use in such applications do so at their own risk. Please contact authorized Vishay personnel to obtain written terms and conditions regarding products designed for such applications.

No license, express or implied, by estoppel or otherwise, to any intellectual property rights is granted by this document or by any conduct of Vishay. Product names and markings noted herein may be trademarks of their respective owners.

## Material Category Policy

**Vishay Intertechnology, Inc. hereby certifies that all its products that are identified as RoHS-Compliant fulfill the definitions and restrictions defined under Directive 2011/65/EU of The European Parliament and of the Council of June 8, 2011 on the restriction of the use of certain hazardous substances in electrical and electronic equipment (EEE) - recast, unless otherwise specified as non-compliant.**

**Please note that some Vishay documentation may still make reference to RoHS Directive 2002/95/EC. We confirm that all the products identified as being compliant to Directive 2002/95/EC conform to Directive 2011/65/EU.**

**Vishay Intertechnology, Inc. hereby certifies that all its products that are identified as Halogen-Free follow Halogen-Free requirements as per JEDEC JS709A standards. Please note that some Vishay documentation may still make reference to the IEC 61249-2-21 definition. We confirm that all the products identified as being compliant to IEC 61249-2-21 conform to JEDEC JS709A standards.**